

CBP10

Made in Taiwan

Electrical Rating	15A 300VAC
Housing Material	Plastic NYLON 66, Black (UL 94V-0)
Terminal	Brass, 0.8t Tin Plated
Screw	Steel, M3, Nickel Plated
Working Temperature	-40°C to +105°C
Insulation withstand Voltage	AC2000V at 1 min
Insulation resistance	500MΩ or more at DC 500V
Wire Range	22~12 AWG
Max. Torque Value	10Kg/cm
Number of Poles	2P~28P
Pitch (terminal to terminal)	10mm

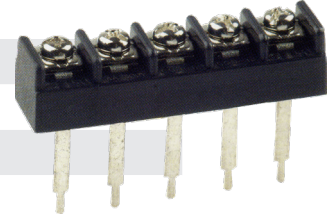

CBP10-01

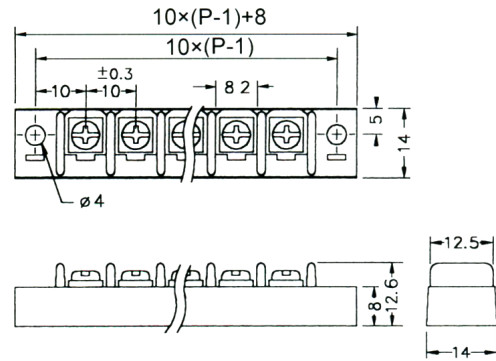

Unit : mm

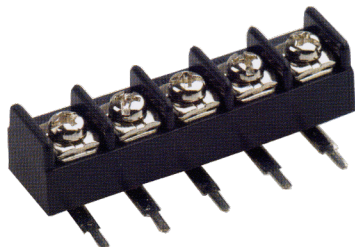

CBP10-02

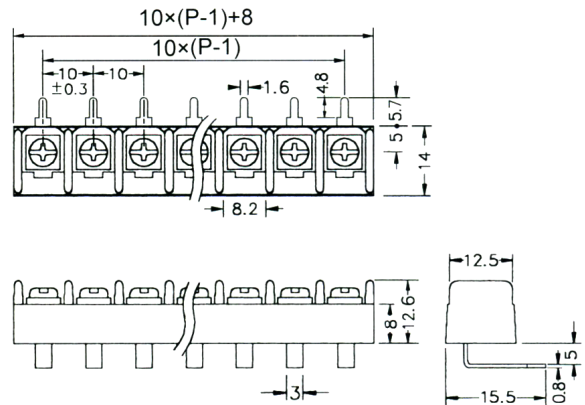

Unit : mm

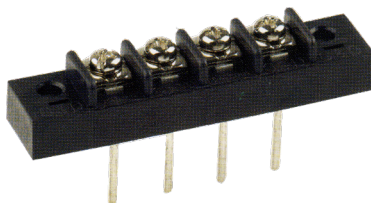

CBP10-03

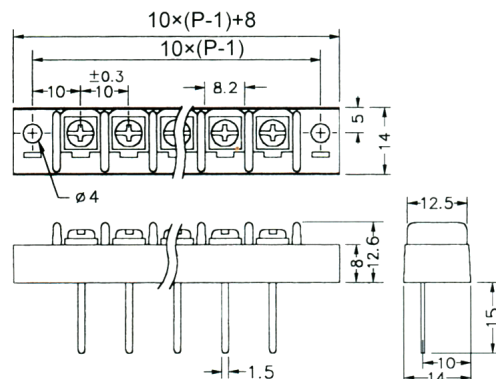

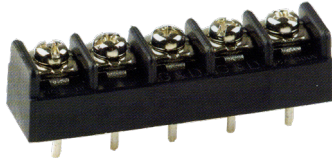

CBP10-04

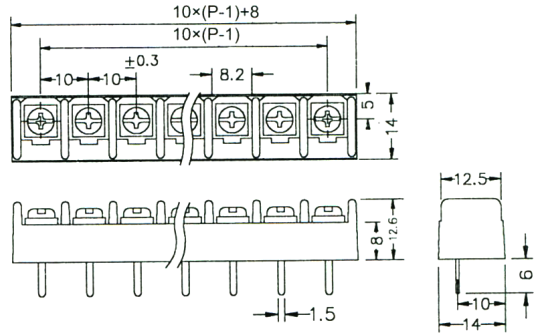

Unit : mm

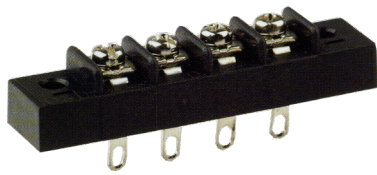

CBP10-05

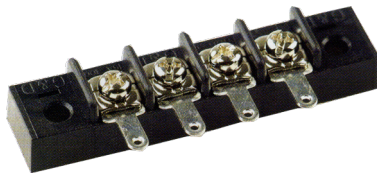
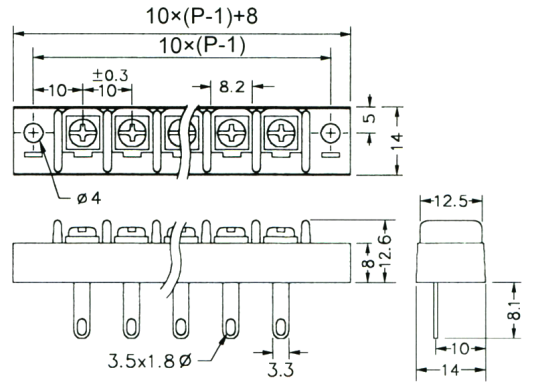

CBP10-07

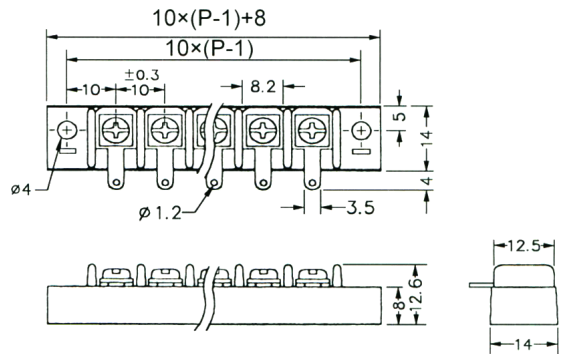

Unit : mm

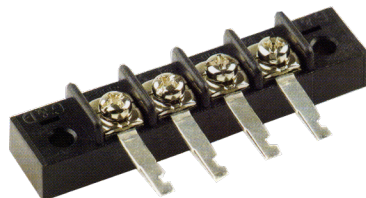

CBP10-08

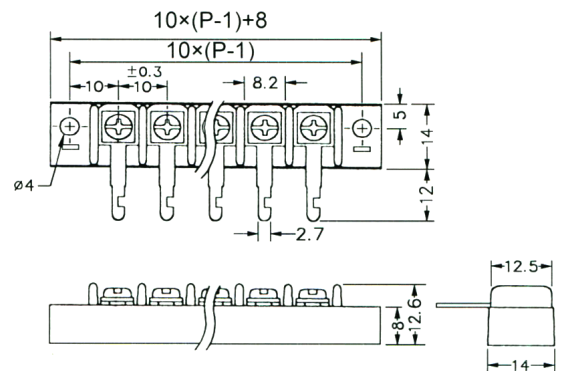

CBP20

Cover Available

Made in Taiwan

Electrical Rating	15A 300VAC
Housing Material	Plastic NYLON 66, Black (UL 94V-0)
Terminal	Brass, 0.8t Tin Plated
Screw	Steel, M3.5, Nickel Plated
Working Temperature	-40°C to +105°C
Insulation withstand Voltage	AC2000V at 1 min
Insulation resistance	500MΩ or more at DC 500V
Wire Range	22~12 AWG
Max. Torque Value	12Kg/cm
Number of Poles	2P~32P
Pitch (terminal to terminal)	9.5mm

Unit : mm



CBP20-01

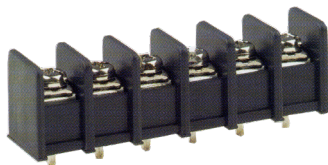
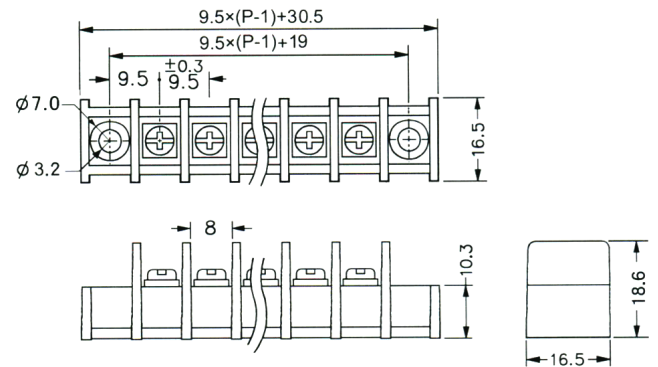

CBP20-02

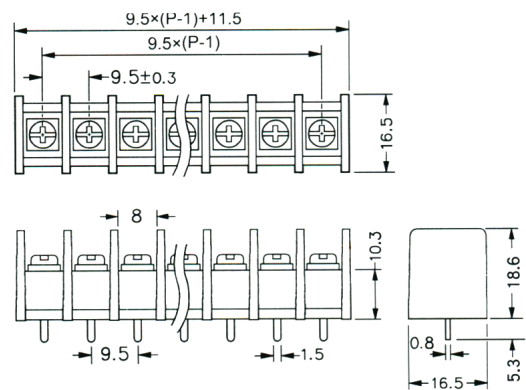

Unit : mm

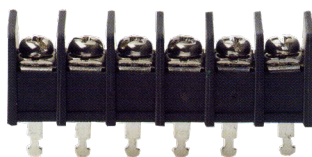

CBP20-03

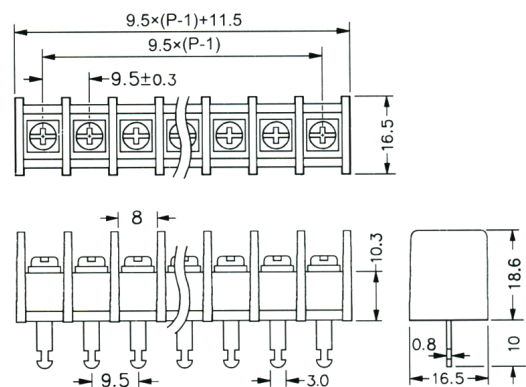

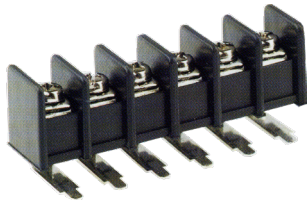

CBP20-04

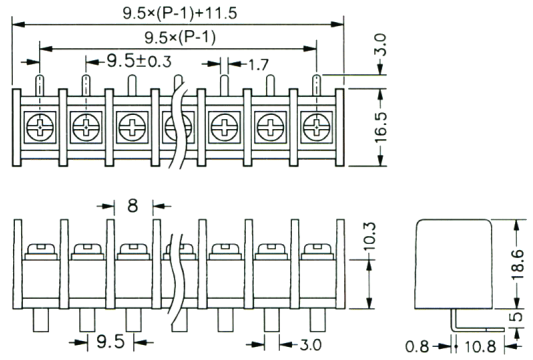

Unit : mm

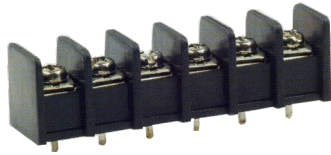

CBP20-05

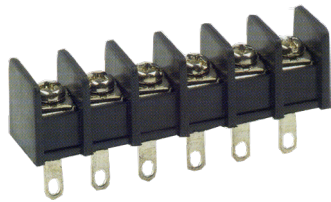
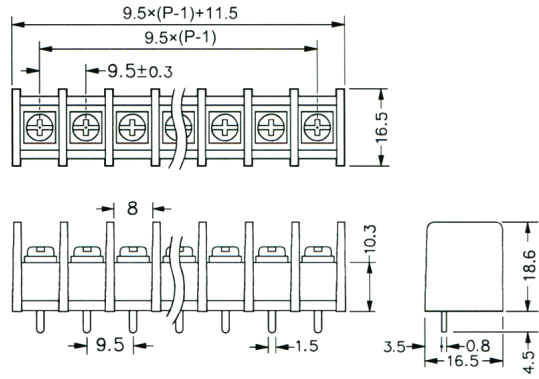

CBP20-06

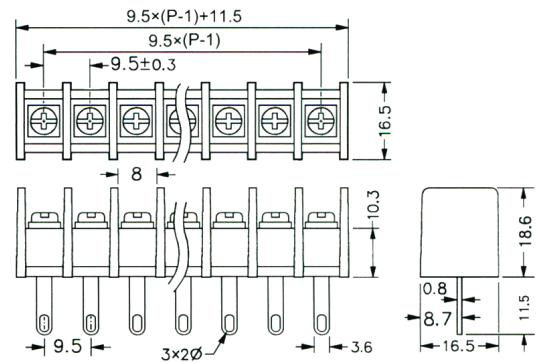

Unit : mm

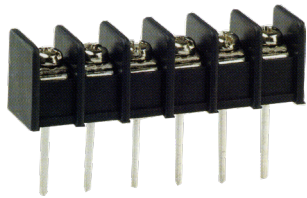

CBP20-07

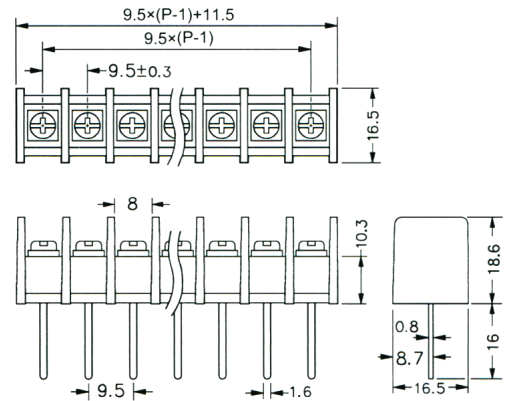

CBP30

Cover Available

Made in Taiwan

Electrical Rating	30A 300VAC
Housing Material	Plastic NYLON 66, Black (UL 94V-0)
Terminal	Brass, 0.8t Tin Plated
Screw	Steel, M4, Nickel Plated
Working Temperature	-40°C to +105°C
Insulation withstand Voltage	AC2000V at 1 min
Insulation resistance	500MΩ or more at DC 500V
Wire Range	22~12 AWG
Max. Torque Value	18Kg/cm
Number of Poles	2P~29P
Pitch (terminal to terminal)	11mm



CBP30-01

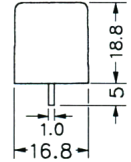
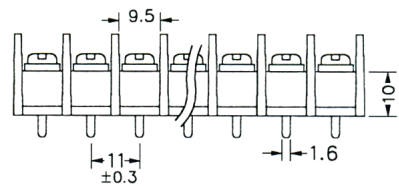
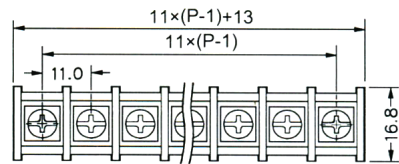

Unit : mm

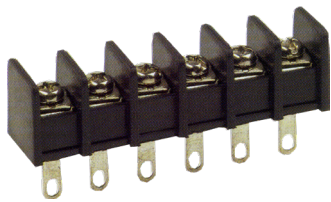

CBP30-01

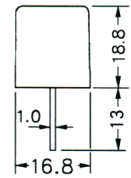
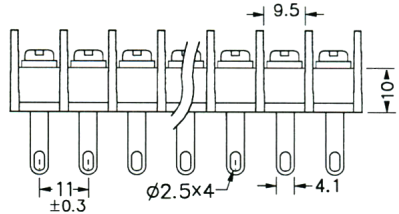
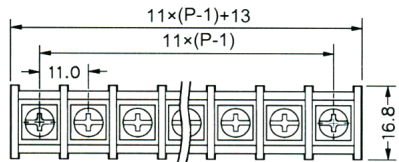

Unit : mm

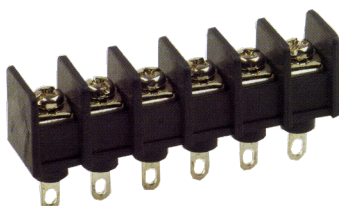

CBP30-01

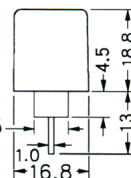
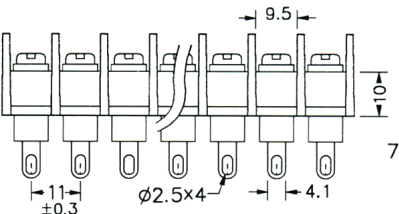
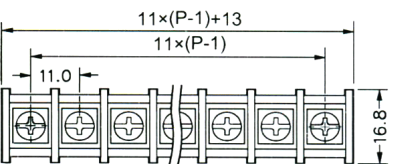

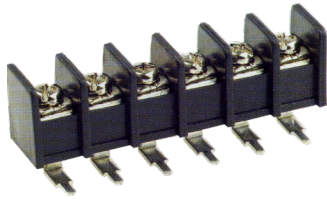

CBP30-04

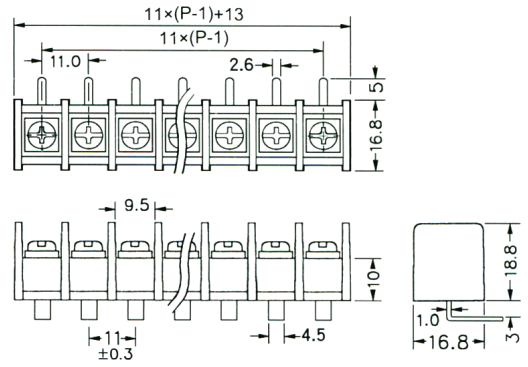

Unit : mm

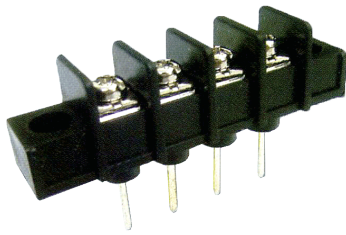

CBP30-05

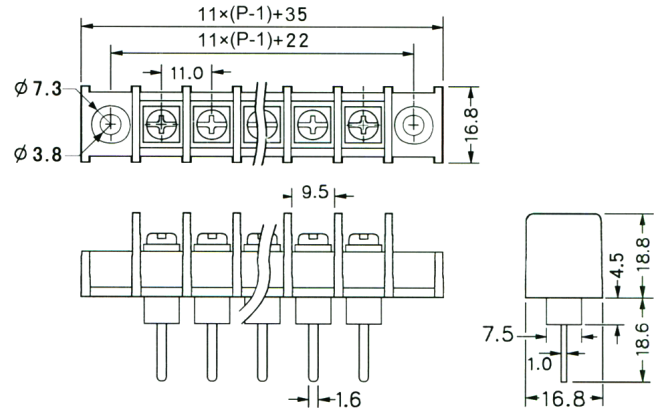

CBP40

Cover Available

Made in Taiwan

Electrical Rating	20A 300VAC
Housing Material	Plastic NYLON 66, Black (UL 94V-0)
Terminal	Brass, 0.8t Tin Plated
Screw	Steel, M3.5, Nickel Plated
Working Temperature	-40°C to +105°C
Insulation withstand Voltage	AC2000V at 1 min
Insulation resistance	500MΩ or more at DC 500V
Wire Range	22~12 AWG
Max. Torque Value	12Kg/cm
Number of Poles	2P~30P
Pitch (terminal to terminal)	10mm

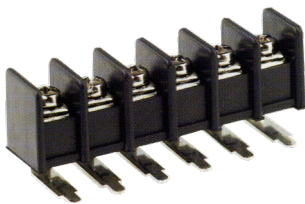
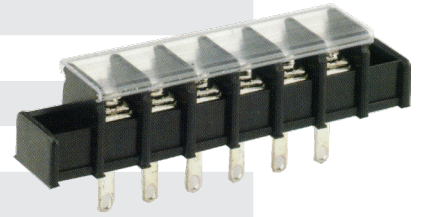

CBP40-01

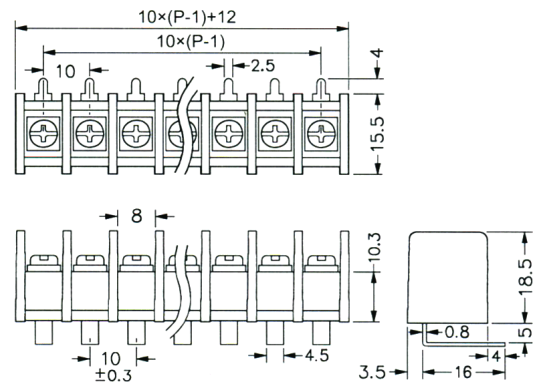

CBP40-02

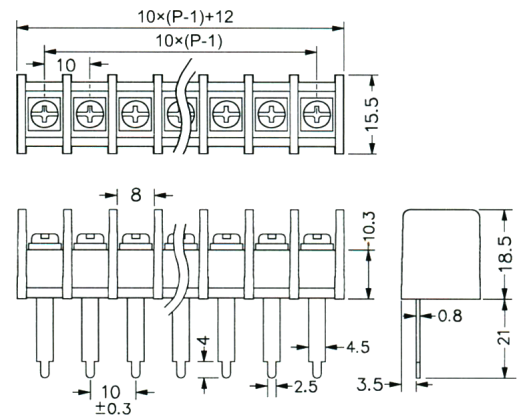

CBP40-03

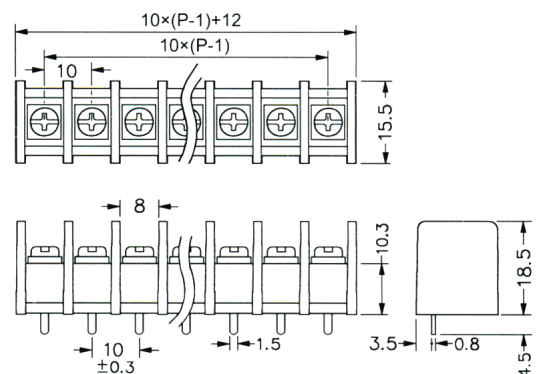

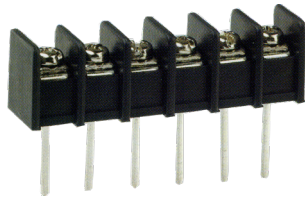

CBP40-04

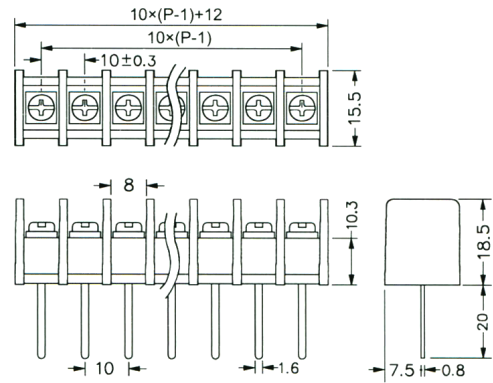

Unit : mm

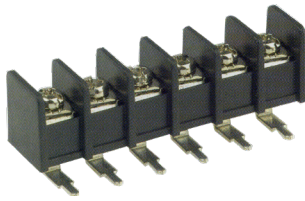

CBP40-05

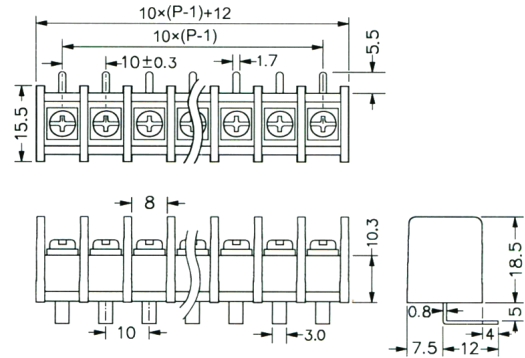

Unit : mm

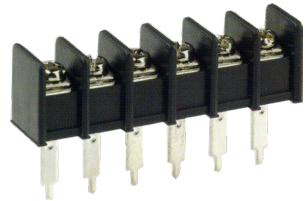

CBP40-06

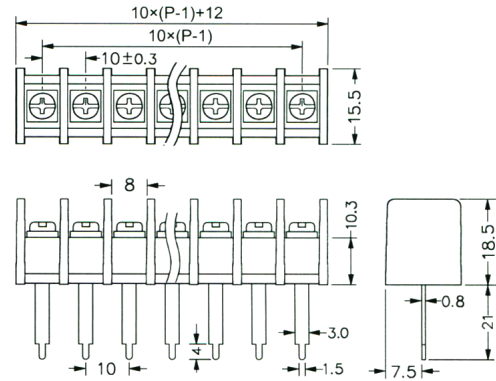

Unit : mm



CBP40-07

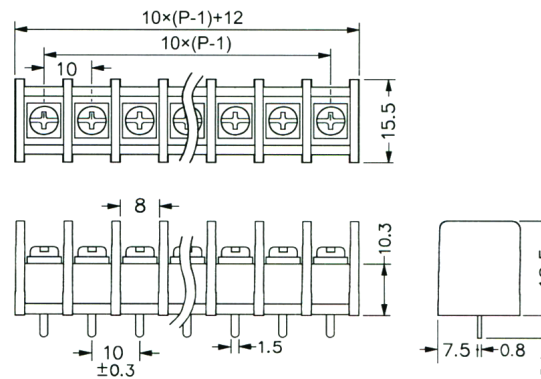

Unit : mm

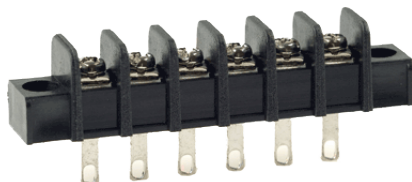

CBP40-08

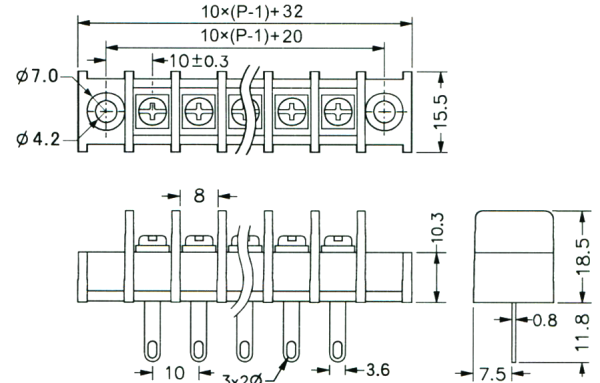

Unit : mm

CBP60

Made in Taiwan

Electrical Rating	10A 300VAC
Housing Material	Plastic NYLON 66, Black (UL 94V-0)
Terminal	Brass, 0.8t Tin Plated
Screw	Steel, M3, Nickel Plated
Working Temperature	-40°C to +105°C
Insulation withstand Voltage	AC2000V at 1 min
Insulation resistance	500MΩ or more at DC 500V
Wire Range	22~12 AWG
Max. Torque Value	10Kg/cm
Number of Poles	2P~32P
Pitch (terminal to terminal)	6.35mm

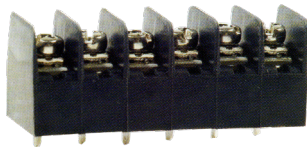

CBP60-01

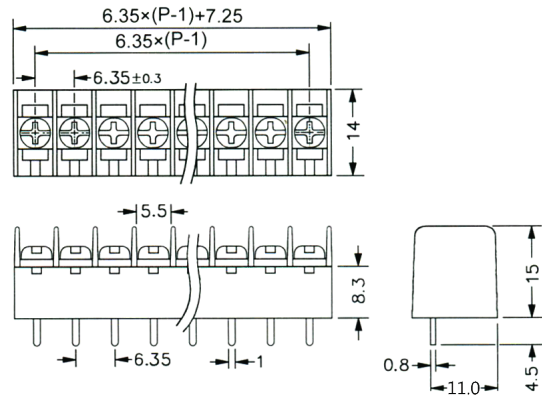

Unit : mm

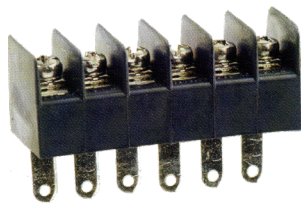

CBP60-02

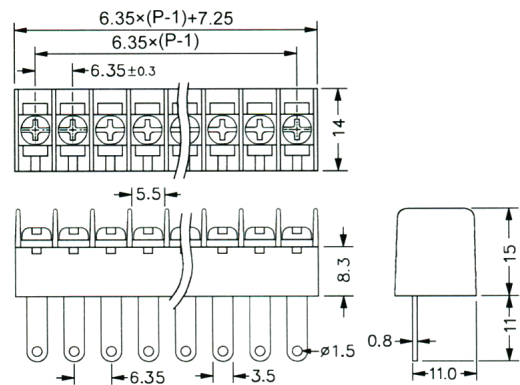

CBP70

Cover Available

Made in Taiwan

Electrical Rating	10A 300VAC
Housing Material	Plastic NYLON 66, Black (UL 94V-0)
Terminal	Brass, 0.8t Tin Plated
Screw	Steel, M3, Nickel Plated
Working Temperature	-40°C to +105°C
Insulation withstand Voltage	AC2000V at 1 min
Insulation resistance	500MΩ or more at DC 500V
Wire Range	22~12 AWG
Max. Torque Value	10Kg/cm
Number of Poles	2P~32P
Pitch (terminal to terminal)	7.62mm

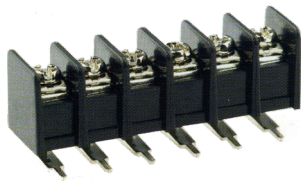
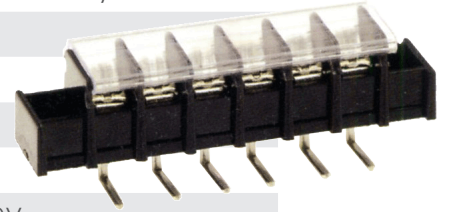

CBP70-01

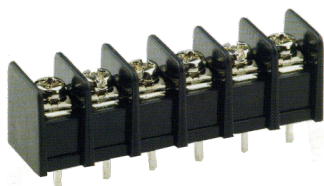
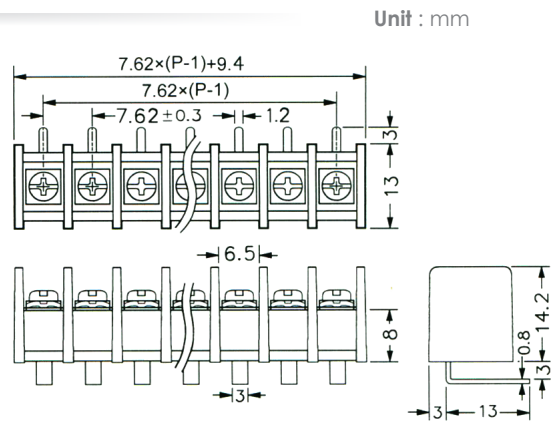

CBP70-02

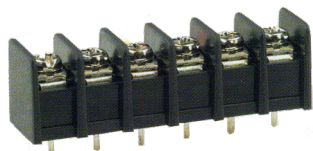
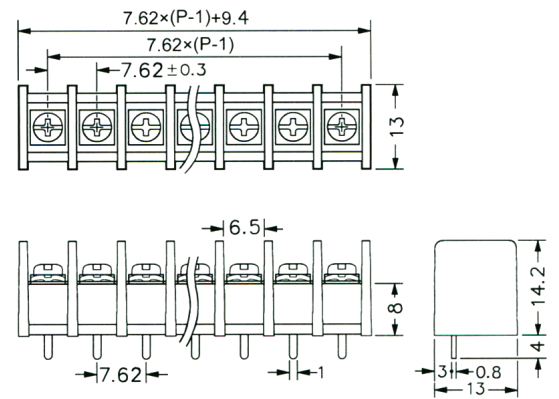

CBP70-03

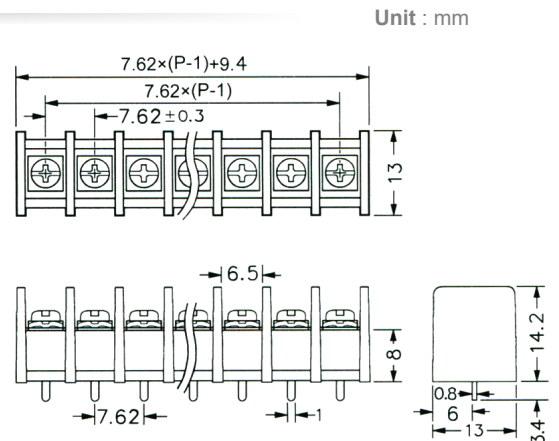

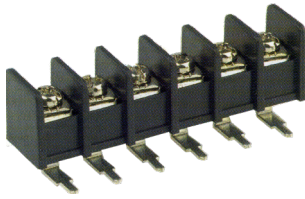

CBP70-04A

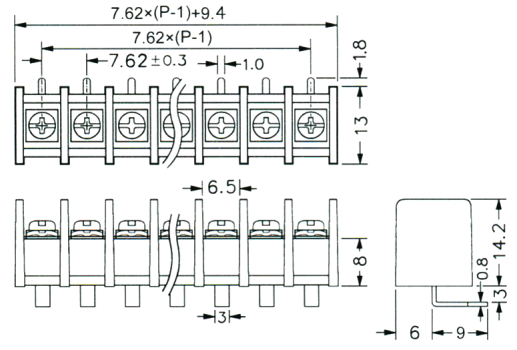

Unit : mm

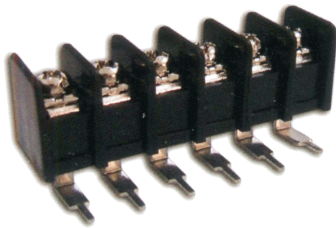

CBP70-04B

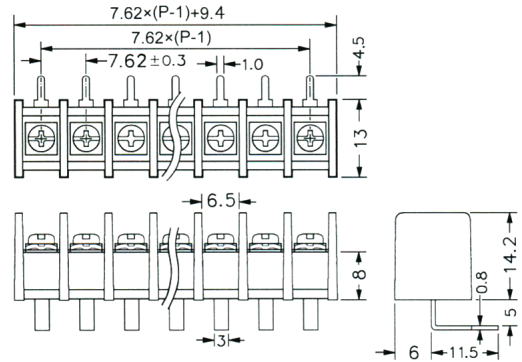

Unit : mm

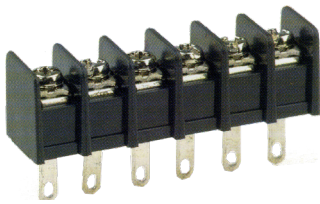

CBP70-05

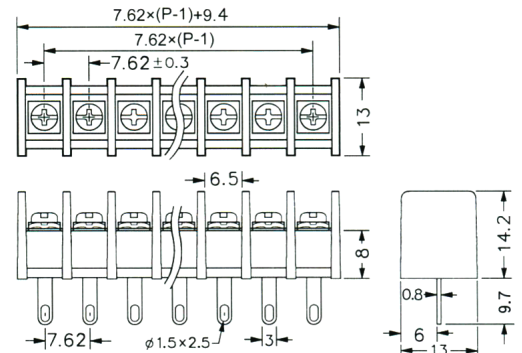

Unit : mm

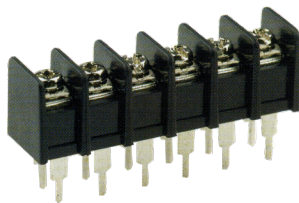

CBP70-06

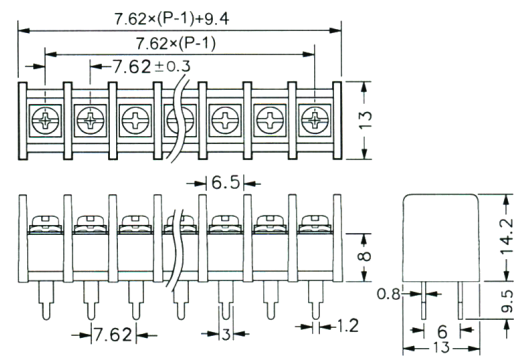

Unit : mm

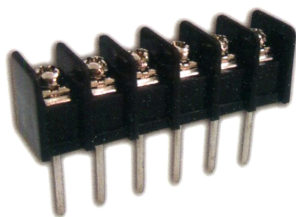

CBP70-07

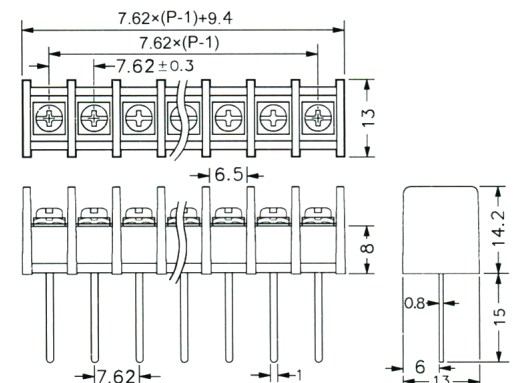

Unit : mm

CBP100

Made in Taiwan

Electrical Rating	15A 300VAC
Housing Material	Plastic NYLON 66, Black (UL 94V-0)
Terminal	Brass, 0.8t Tin Plated
Screw	Steel, M3, Nickel Plated
Working Temperature	-40°C to +105°C
Insulation withstand Voltage	AC2000V at 1 min
Insulation resistance	500MΩ or more at DC 500V
Wire Range	22~12 AWG
Max. Torque Value	10Kg/cm
Number of Poles	2P~32P
Pitch (terminal to terminal)	8.25mm

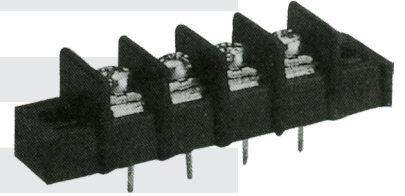

Unit : mm

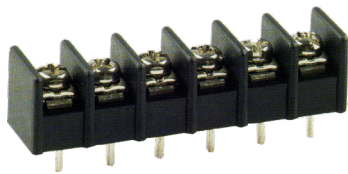

CBP100-01

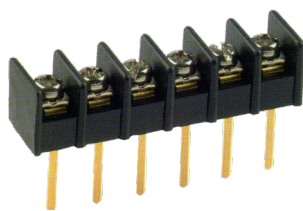
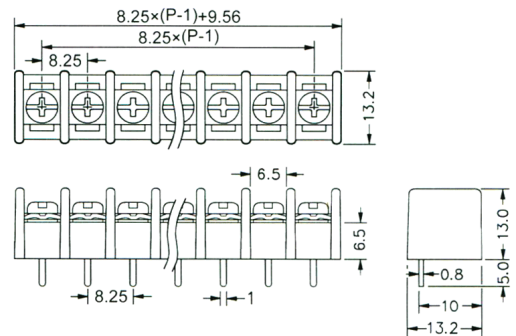

CBP100-02

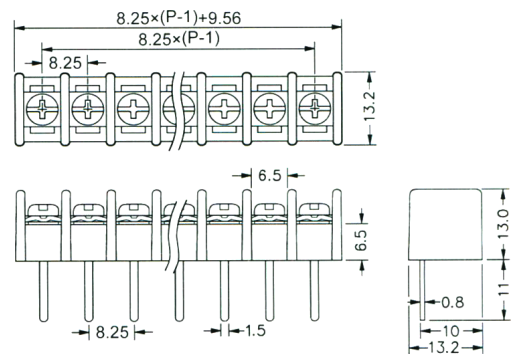

Unit : mm

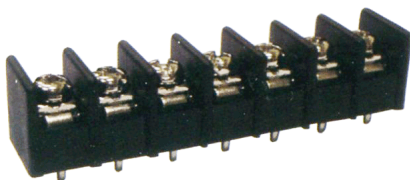

CBP100-03

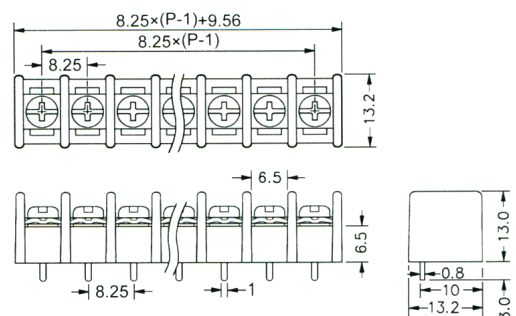

CBP210

Cover Available

Made in Taiwan

Electrical Rating	15A 300VAC
Housing Material	Plastic NYLON 66, Black (UL 94V-0)
Terminal	Brass, 0.8t Tin Plated
Screw	Steel, M3, Nickel Plated
Working Temperature	-40°C to +105°C
Insulation withstand Voltage	AC2000V at 1 min
Insulation resistance	500MΩ or more at DC 500V
Wire Range	22~12 AWG
Max. Torque Value	10Kg/cm
Number of Poles	2P~32P
Pitch (terminal to terminal)	10mm

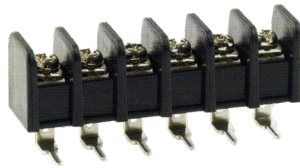
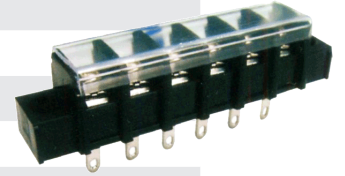

CBP210-01

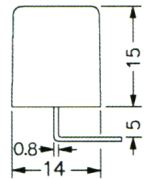
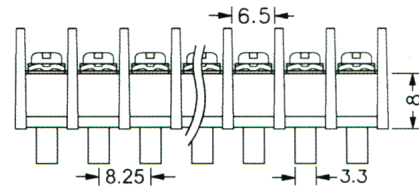
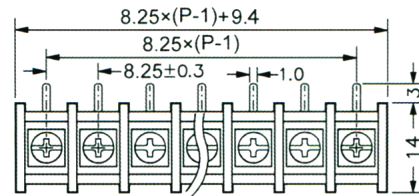

Unit : mm

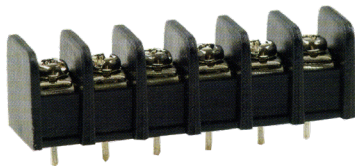

CBP210-02

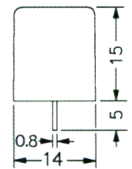
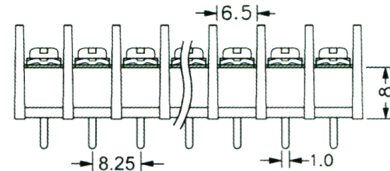
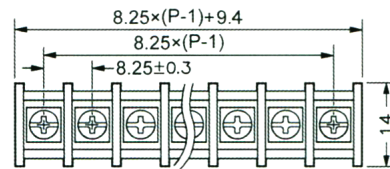

Unit : mm

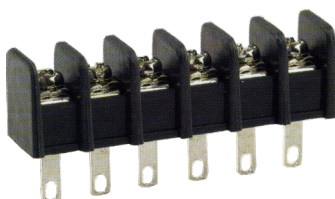

CBP210-03

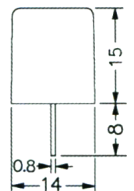
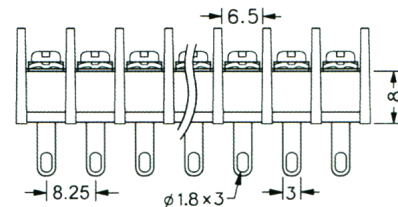
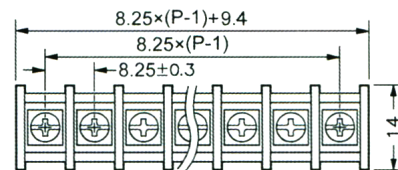

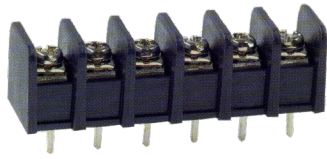

CBP210-04

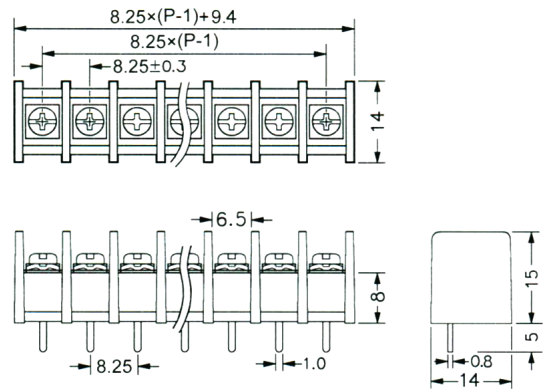

Unit : mm

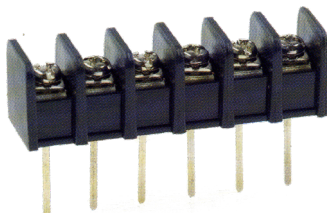

CBP210-05

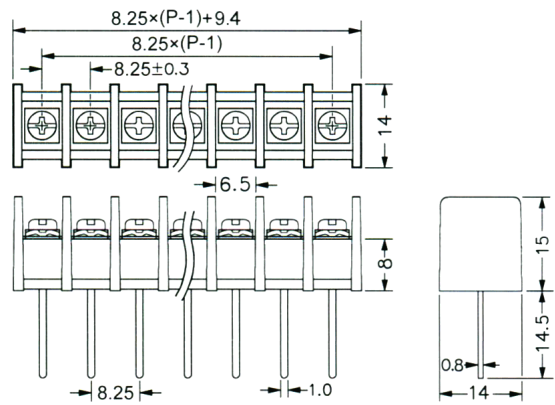

CBP50

Made in Taiwan

Electrical Rating	15A 300VAC
Housing Material	Plastic NYLON 66, Black (UL 94V-0)
Terminal	Brass, 0.8t Tin Plated
Screw	Steel, M4, Nickel Plated
Working Temperature	-40°C to +105°C
Insulation withstand Voltage	AC2000V at 1 min
Insulation resistance	500MΩ or more at DC 500V
Wire Range	22~12 AWG
Max. Torque Value	18Kg/cm
Number of Poles	2P~32P
Pitch (terminal to terminal)	11mm

Unit : mm

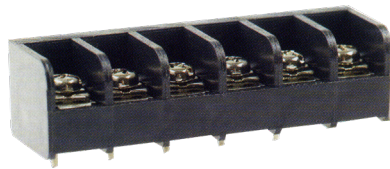

CBP50-01

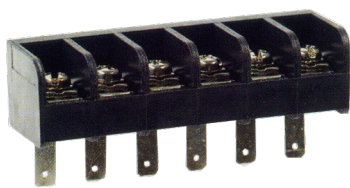
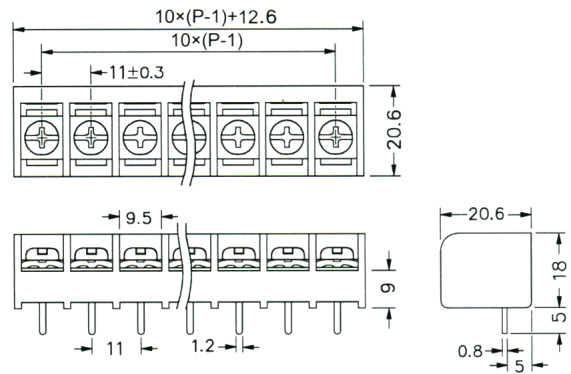

CBP50-02

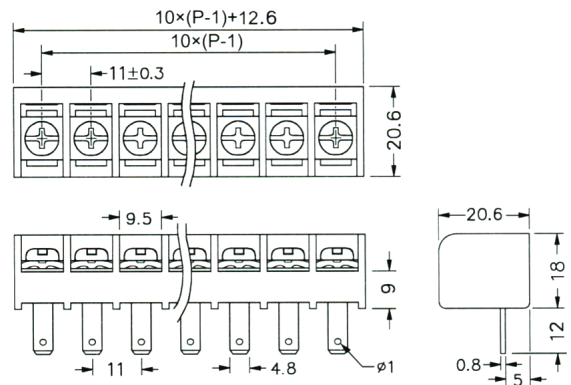

Unit : mm

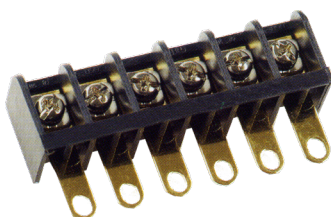

CBP50-03

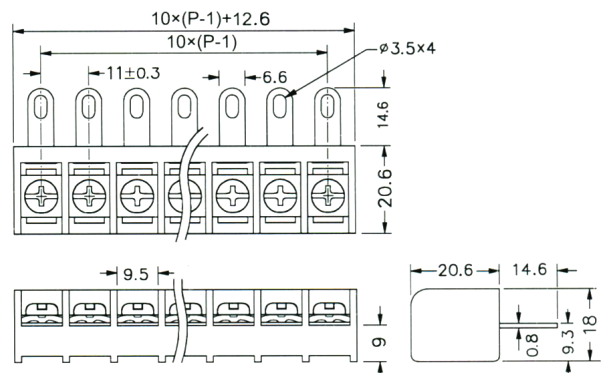

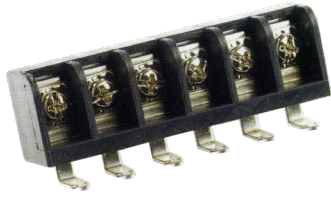

CBP50-04

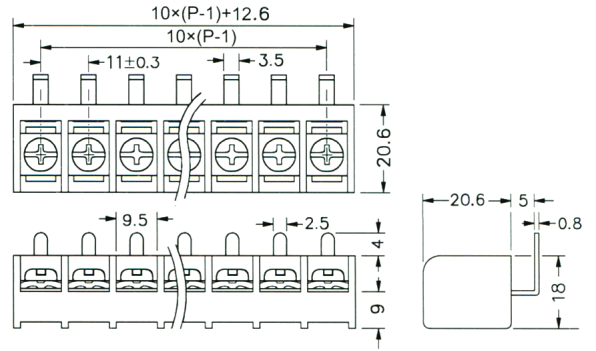

Unit : mm

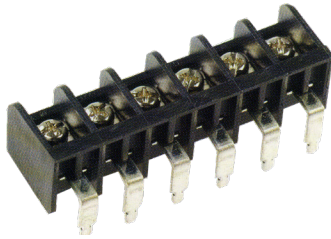

CBP50-05

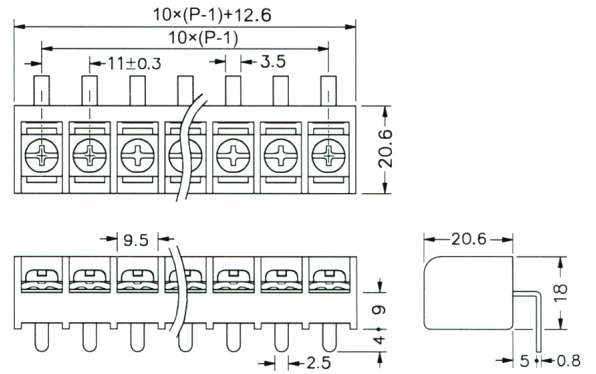

CBP80

Made in Taiwan

Electrical Rating	15A 300VAC
Housing Material	Plastic NYLON 66, Black (UL 94V-0)
Terminal	Brass, 0.8t Tin Plated
Screw	Steel, M3, Nickel Plated
Working Temperature	-40°C to +105°C
Insulation withstand Voltage	AC2000V at 1 min
Insulation resistance	500MΩ or more at DC 500V
Wire Range	22~12 AWG
Max. Torque Value	10Kg/cm
Number of Poles	2P~32P
Pitch (terminal to terminal)	8.25mm



CBP80-01

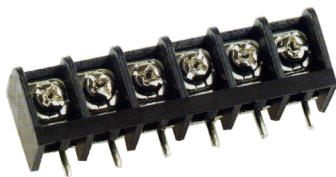
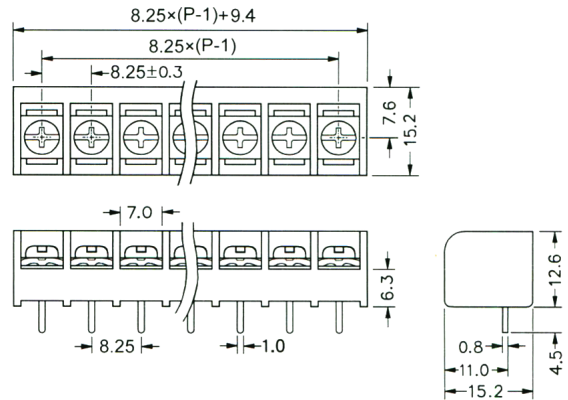

CBP80-02

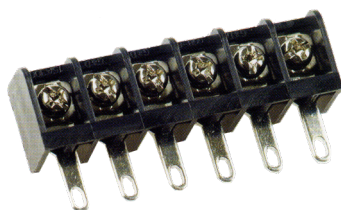
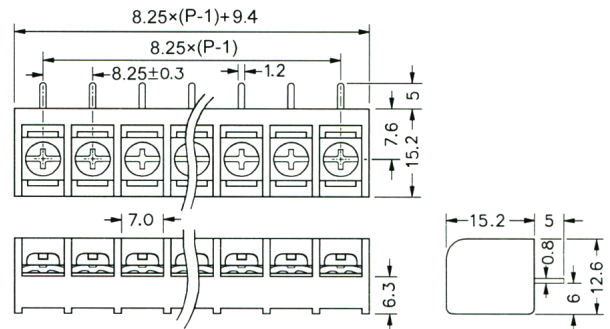

CBP80-03

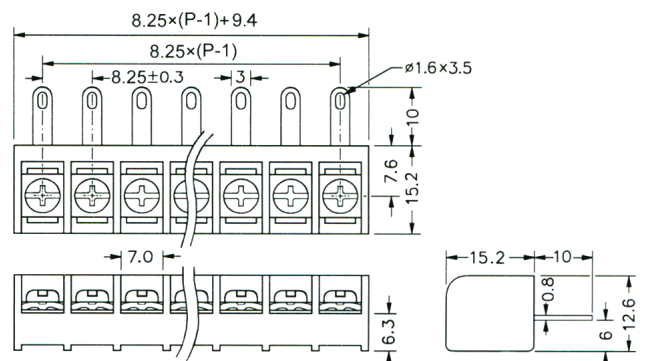

Unit : mm

Unit : mm

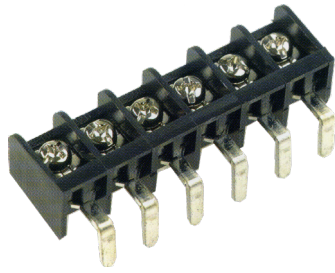

CBP80-04

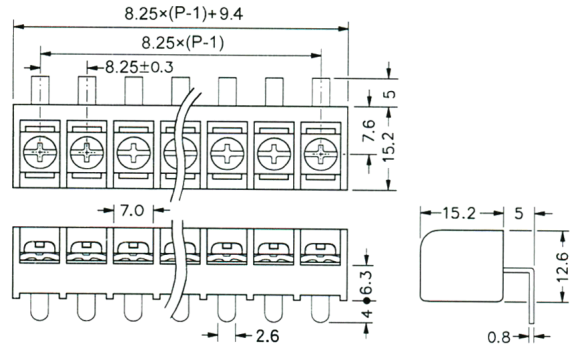

Unit : mm

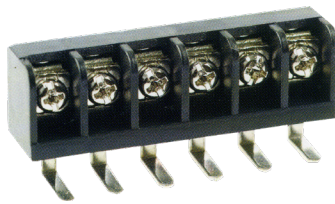

CBP80-05

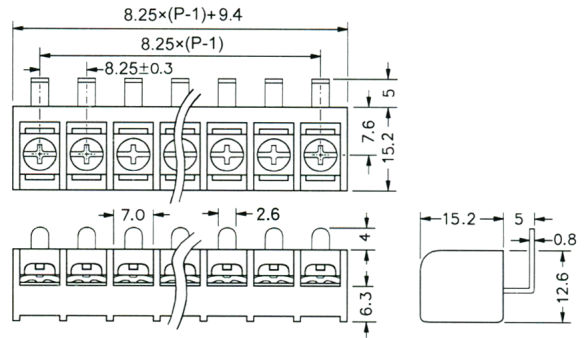

CBP90

Made in Taiwan

Electrical Rating	15A 300VAC
Housing Material	Plastic NYLON 66, Black (UL 94V-0)
Terminal	Brass, 0.8t Tin Plated
Screw	Steel, M3.5, Nickel Plated
Working Temperature	-40°C to +105°C
Insulation withstand Voltage	AC2000V at 1 min
Insulation resistance	500MΩ or more at DC 500V
Wire Range	22~12 AWG
Max. Torque Value	12Kg/cm
Number of Poles	2P~32P
Pitch (terminal to terminal)	9.5mm

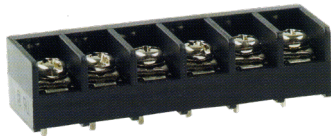

CBP90-01

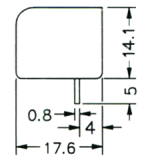
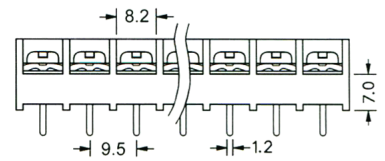
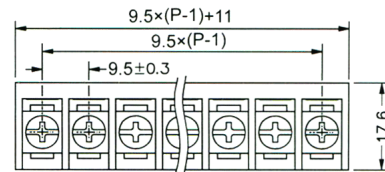

Unit : mm

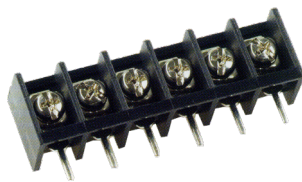

CBP90-02

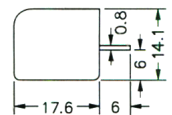
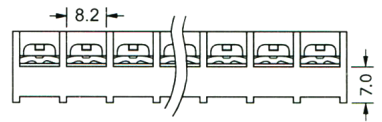
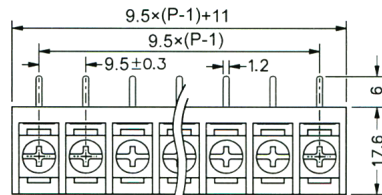

Unit : mm

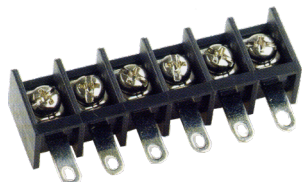

CBP90-03

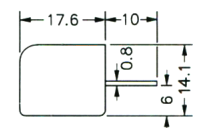
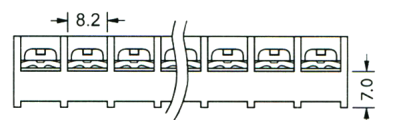
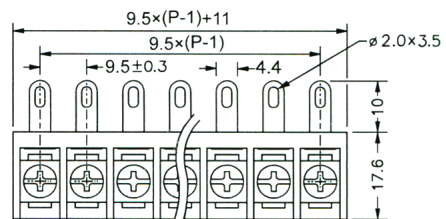



CBP90-04

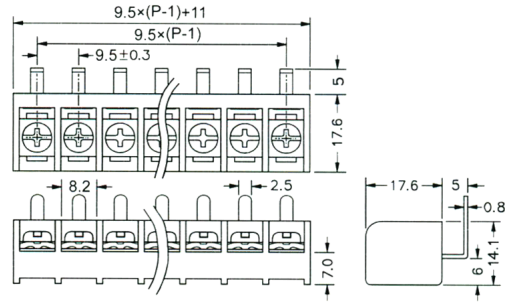

Unit : mm

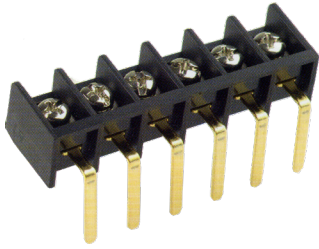

CBP90-05

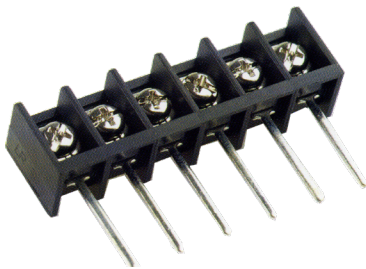
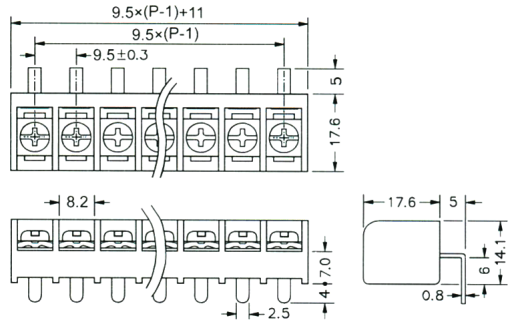

CBP90-06

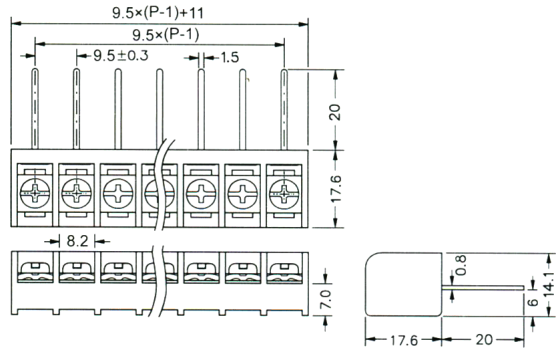

Unit : mm

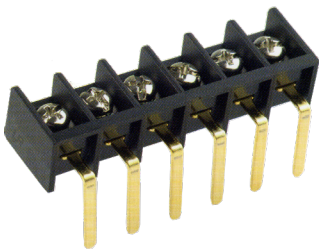

CBP90-07

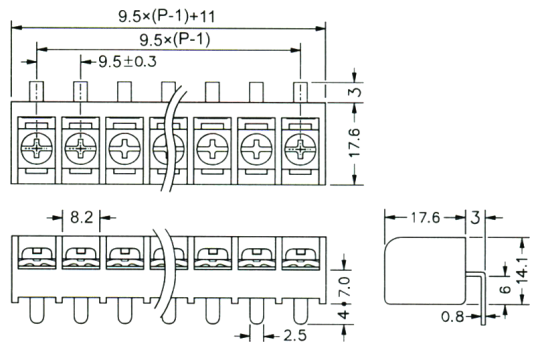

Unit : mm

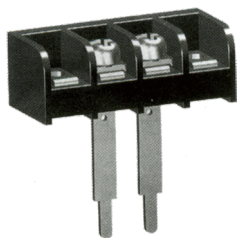

CBP90-08

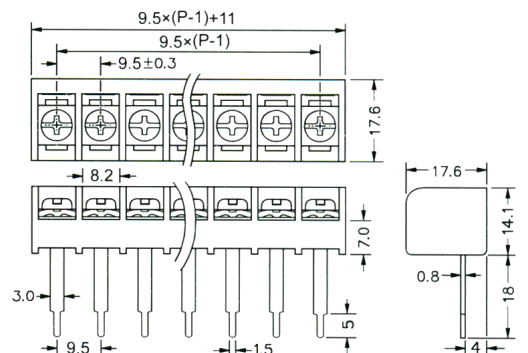

CBP140

Made in Taiwan

Electrical Rating	10A 300VAC
Housing Material	Plastic NYLON 66, Black (UL 94V-0)
Terminal	Brass, 0.8t Tin Plated
Screw	Steel, M3, Nickel Plated
Working Temperature	-40°C to +105°C
Insulation withstand Voltage	AC2000V at 1 min
Insulation resistance	500MΩ or more at DC 500V
Wire Range	22~12 AWG
Max. Torque Value	10Kg/cm
Number of Poles	2P~32P
Pitch (terminal to terminal)	6.35mm

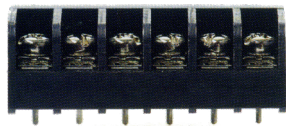

CBP140-01

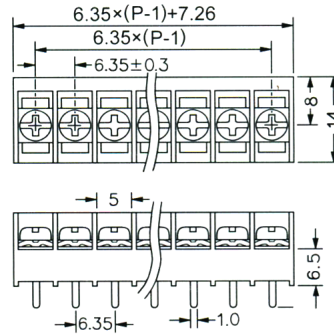

Unit : mm

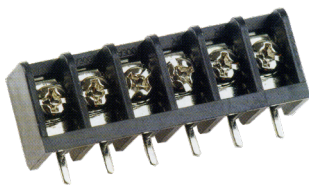
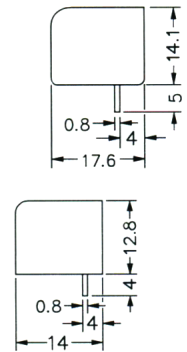

CBP140-02

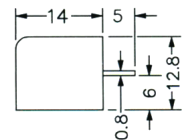
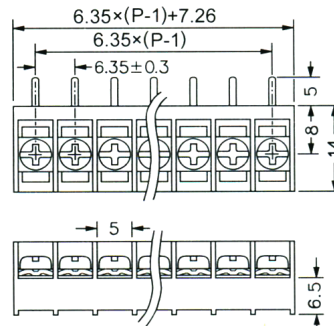

Unit : mm

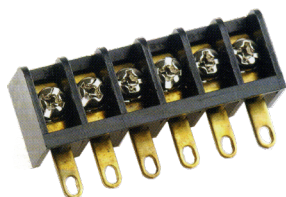

CBP140-03

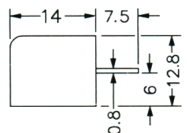
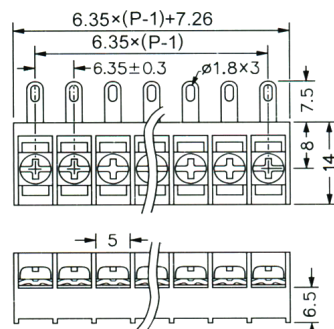

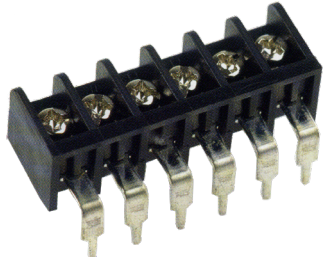

CBP140-04

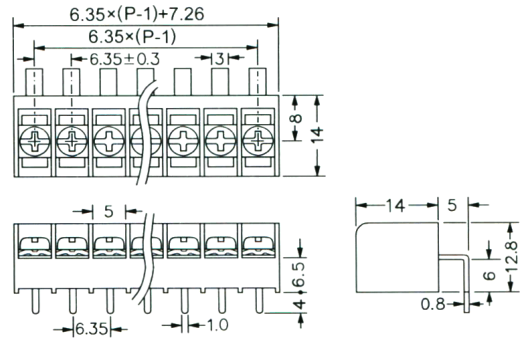

Unit : mm

CBP110

Made in Taiwan

Electrical Rating	15A 300VAC
Housing Material	Plastic NYLON 66, Black (UL 94V-0)
Terminal	Brass, 0.8t Tin Plated
Screw	Steel, M3, Nickel Plated
Working Temperature	-40°C to +105°C
Insulation withstand Voltage	AC2000V at 1 min
Insulation resistance	500MΩ or more at DC 500V
Wire Range	22~12 AWG
Max. Torque Value	10Kg/cm
Number of Poles	2x2P~2x26P
Pitch (terminal to terminal)	8.25mm

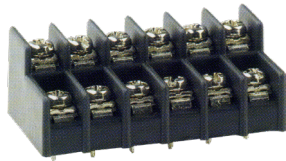

CBP110-01

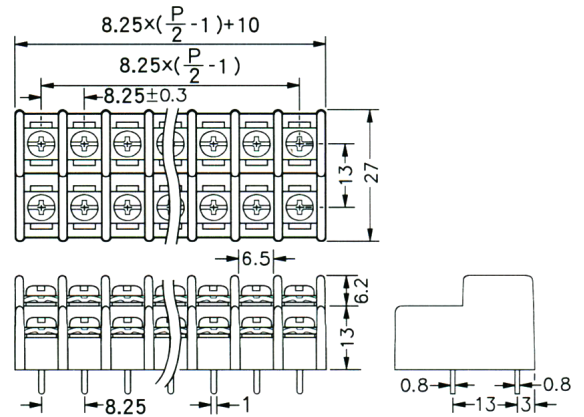

Unit : mm

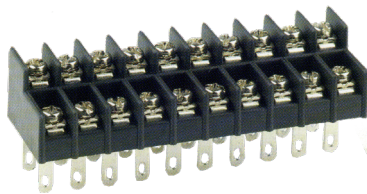

CBP110-02

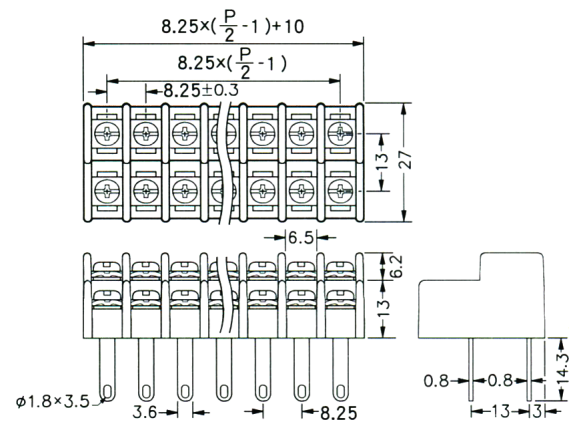

CBP120

Cover Available

Made in Taiwan

Electrical Rating	15A 300VAC
Housing Material	PBT, Black
Terminal	Brass, 0.8t Tin Plated
Screw	Steel, M3, Nickel Plated
Working Temperature	-40°C to +130°C
Insulation withstand Voltage	AC2000V at 1 min
Insulation resistance	500MΩ or more at DC 500V
Wire Range	22~14 AWG
Max. Torque Value	8Kg/cm
Number of Poles	2x2P~2x30P
Pitch (terminal to terminal)	7.62mm

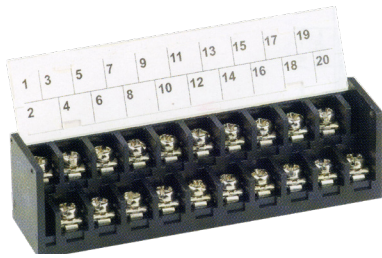

CBP120-01

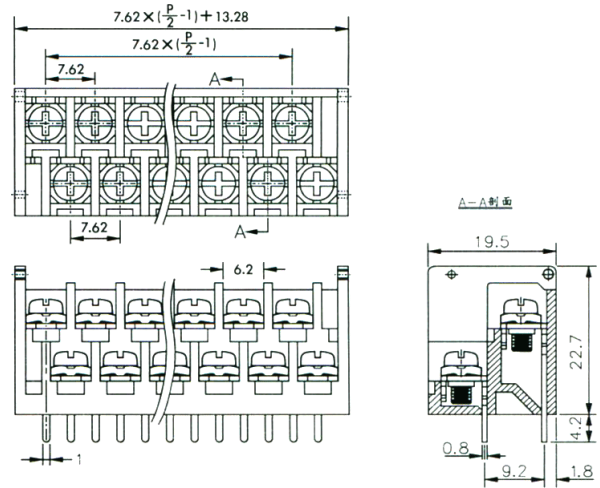

Unit : mm

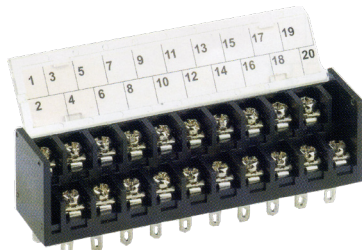

CBP120-02

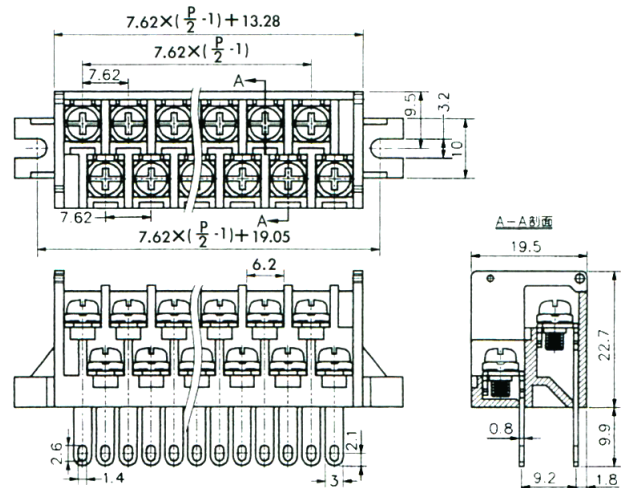

CBP1-381

Made in Taiwan

Electrical Rating	10A 300VAC
Housing Material	Polyamide 66, Green
Contact	Phosphor Bronze, 0.3t, Nickel Plated
Screw	M2.0, Steel, Zinc Plated
Cage clamp	Brass, 0.7t, Nickel Plated
Solder Pin	0.8mm Brass, Tin Plated
Working Temperature	-40°C to +105°C
Insulation withstand Voltage	AC2000V at 1 min
Insulation resistance	500MΩ or more at DC 500V
Wire Range	26~16 AWG
Max. Torque Value	3kg/cm
Number of Poles	2P~16P
Pitch (terminal to terminal)	3.81mm

Unit : mm

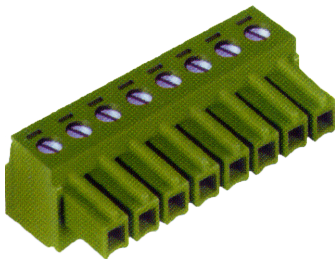

CBP1-381K

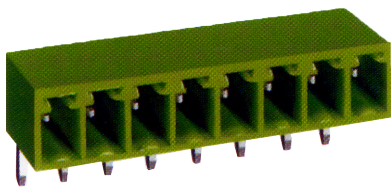
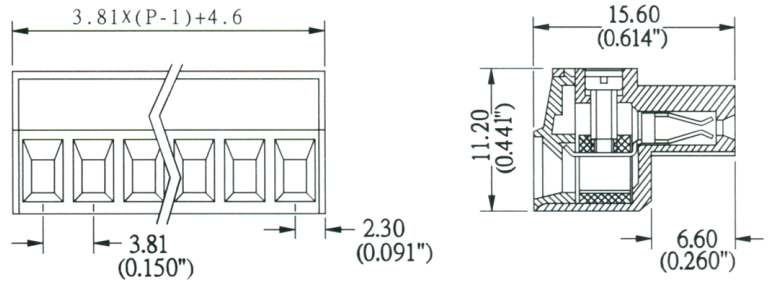

CBP1-381R

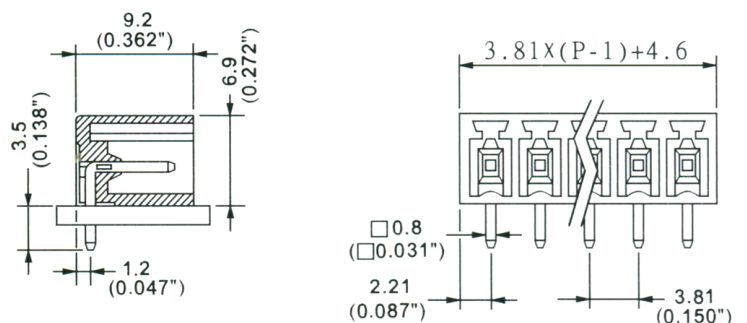

Unit : mm

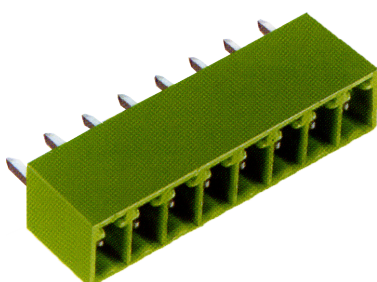

CBP1-381V

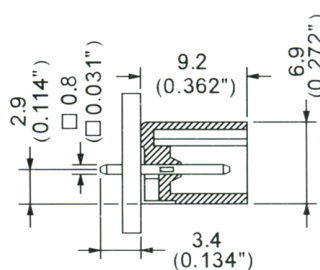

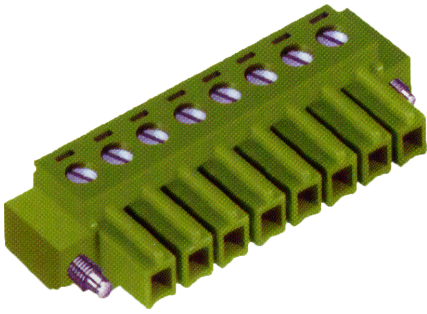

CBP1-381AK

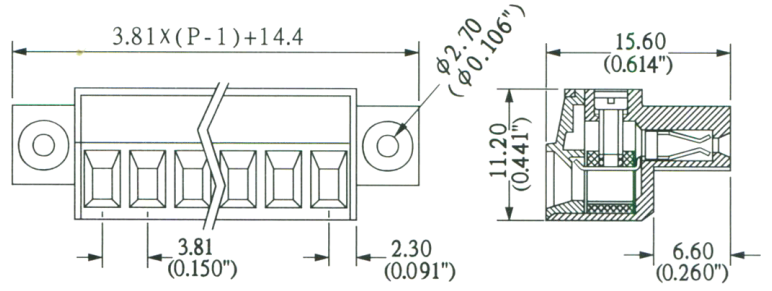

Unit : mm

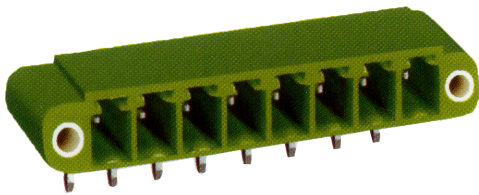

CBP1-381AR

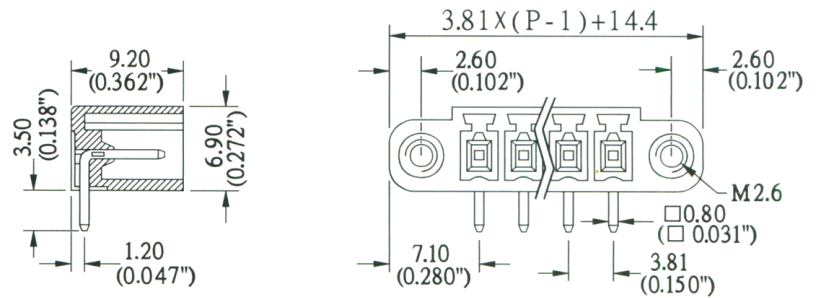

Unit : mm

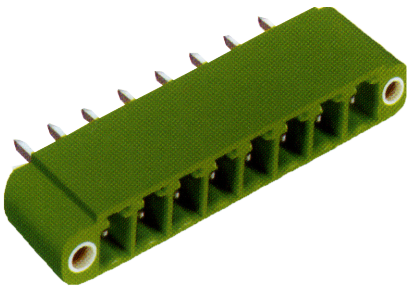

CBP1-381AV

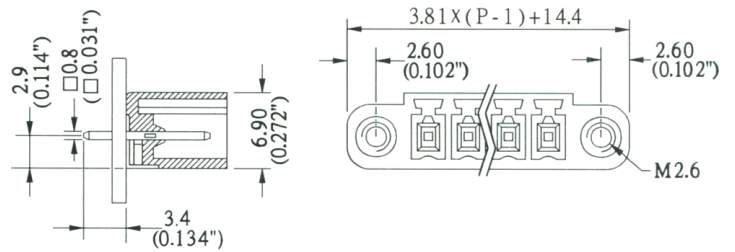

Unit : mm

CBP1-80

Made in Taiwan

Electrical Rating	10A 300VAC
Housing Material	Polyamide 66, Green
Contact	Phosphor Bronze, 0.4t, Nickel Plated
Screw	M2.6, Steel, Zinc Plated
Cage clamp	Brass, 0.7t, Nickel Plated
Solder Pin	Brass, Tin Plated
Working Temperature	-40°C to +105°C
Insulation withstand Voltage	AC2000V at 1 min
Insulation resistance	500MΩ or more at DC 500V
Wire Range	24~14 AWG
Max. Torque Value	5kg/cm
Number of Poles	2P~16P
Pitch (terminal to terminal)	5mm

Unit : mm

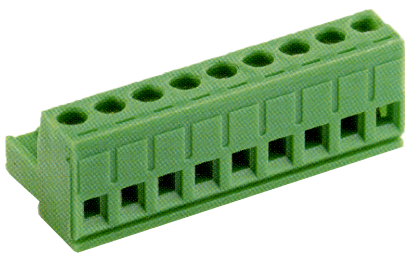

CBP1-80K

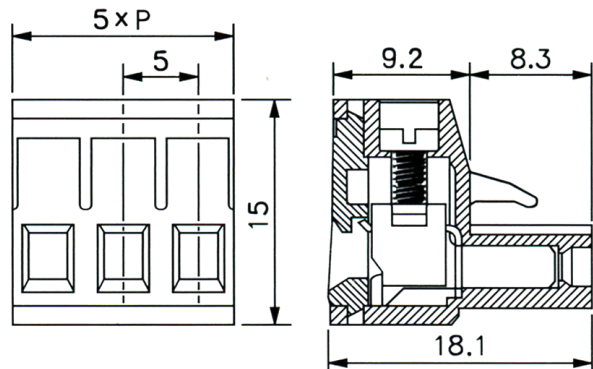

CBP1-80R

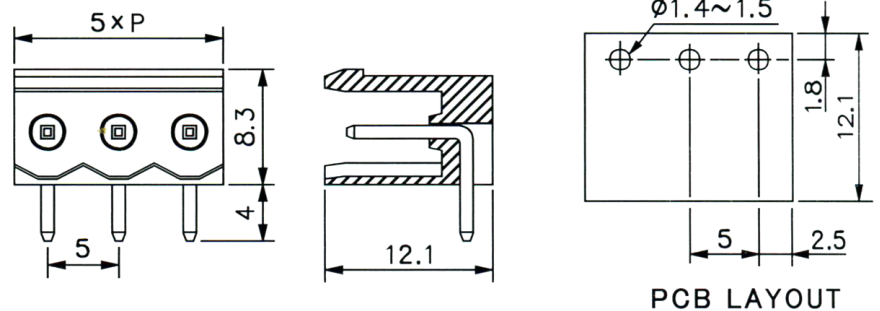

PCB LAYOUT

Unit : mm



CBP1-80V

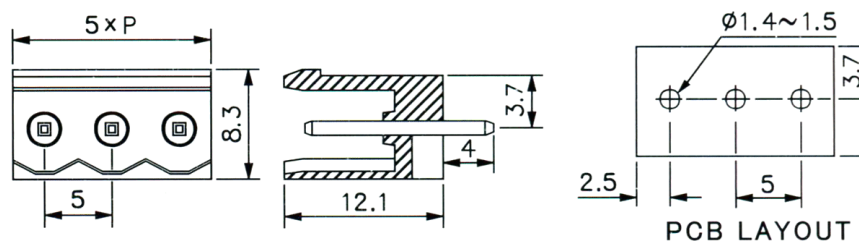

PCB LAYOUT

PCB Terminal Blocks Series

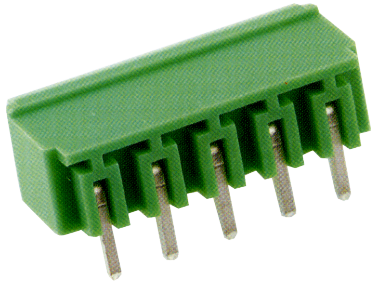

CBP1-80R1

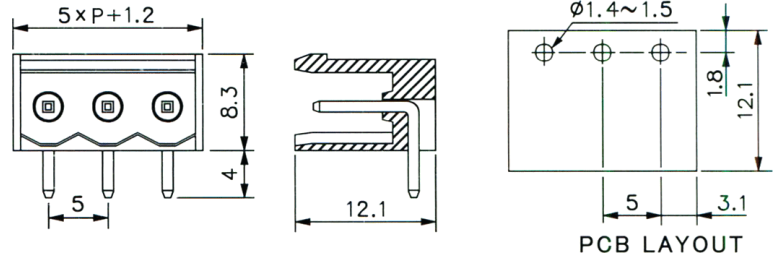

Unit : mm

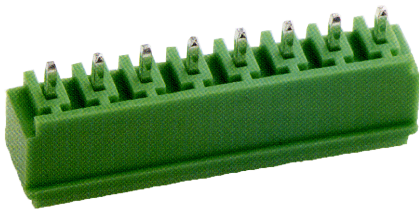

CBP1-80V1

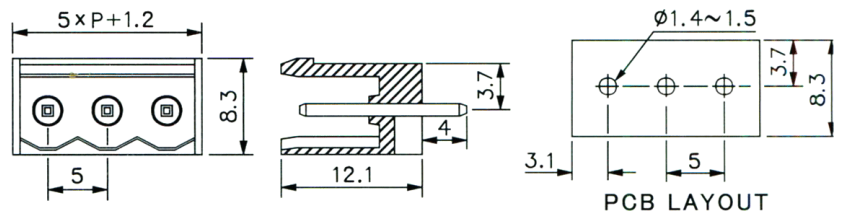

CBP2-HC381

Made in Taiwan

Electrical Rating	10A 300VAC
Housing Material	Polyamide 66, Green
Screw	M2, Steel, Nickel Plated
Wire Cage	Brass, 0.6t, Nickel Plated
Solder Pin	Brass, 0.5t, Tin Plated
Working Temperature	-40°C to +105°C
Insulation withstand Voltage	AC2000V at 1 min
Insulation resistance	500MΩ or more at DC 500V
Wire Range	26~16 AWG
Max. Torque Value	2kg/cm
Number of Poles	2P ~ 16P
Pitch (terminal to terminal)	3.81mm

Unit : mm

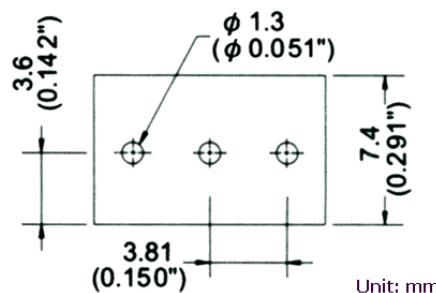
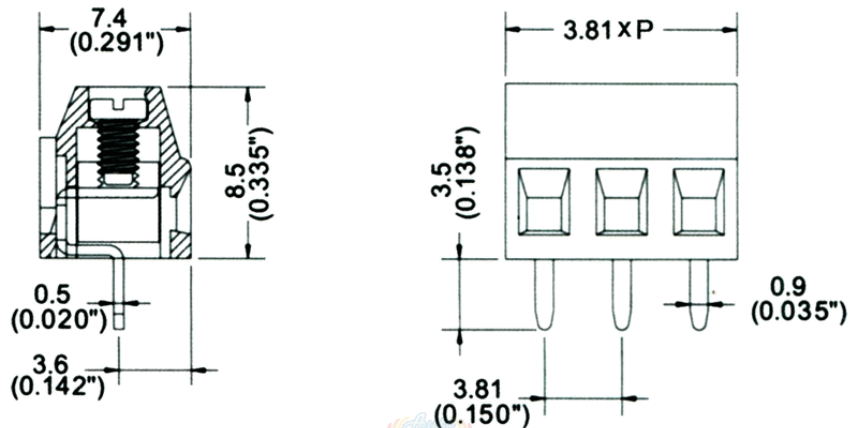
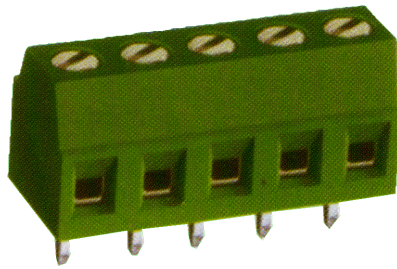

Unit: mm